

METAL DECK ROOF TUBELITE

Tools/Equipment required: • Drill • Metal Shears/Snips • Pliers • Handsaw • Silicone • Rivet Gun

STEP ONE

Locate your desired area of installation within the room required.

By climbing into your roof cavity, make sure there are no obstructions within the installation area (large beams, electrical cables etc).

Proceed to locate a centre point for your installation. Once located, drill a small hole through your ceiling and roof, these will become the centre points for your installation. If you cannot climb inside your roof you may need to lift a roof sheet to locate your centre point.

We recommend installing your tubelite where there no obstacles, however, if you need to remove a batten or a rafter, always replace structure where necessary. If any electrical or plumbing needs to be relocated always use a licensed tradesperson.

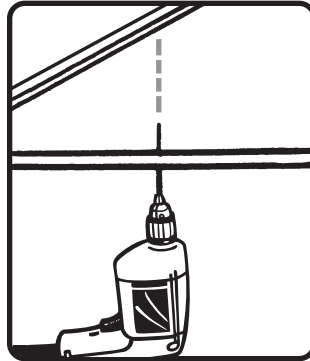

STEP TWO

By using the base flashing as a template, mark out your cutout as follows:

1. Sit the flashing tray in position using your location hole as centre
2. With a pencil, mark out circular opening 'A'
3. Measure down from rear soaker 60mm both sides 'B' and 'C'
4. Remove your flashing tray and draw a line connecting 'B' and 'C'
5. Connect 'B' and 'C' around original centre circle as drawn.

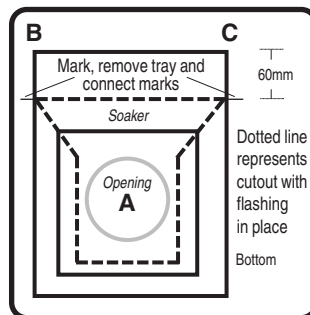

Note: Your cutout is straight not circular. This allows you to turn up roof pans as per Step 3.

STEP THREE

Proceed to cut out the section marked using a pair of shears or snips.

Note: Do not use an angle grinder as this will damage your roof.

Fold up pans of roof sheet as shown to prevent water blowing under (bottom end only).

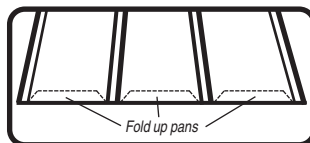
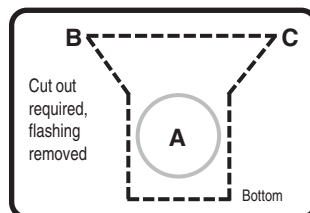

STEP FOUR

Locate flashing tray then mark out the rib profiles on the front of the tray for notching. Proceed to notch out for roof profile.

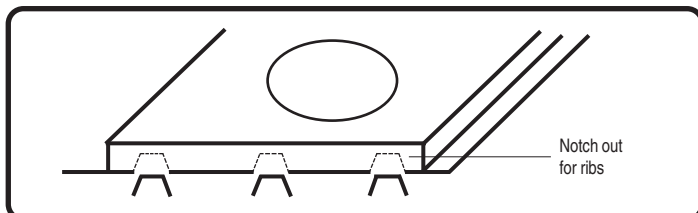

STEP FIVE

Slide rear soaker tray underneath the roof sheet, if possible put a bead of silicone between your roof sheet and soaker tray.

Lift up the front of your flashing and put a generous bead of quality silicone beneath where both side turnouts meet the roof sheet. Continue to bead the full length of these turnouts.

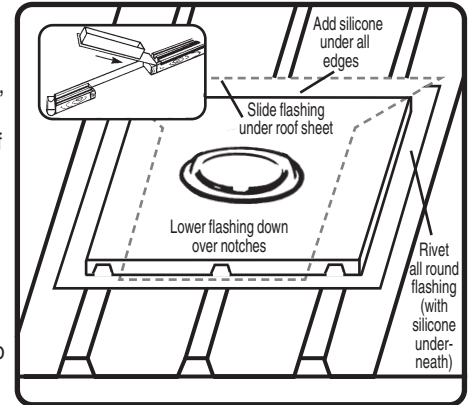

Lower the flashing into the position and fix using rivets approx 30mm apart.

Fix the rear soaker tray again using rivets, then fully seal using a quality silicone. Once sealed, flashing is now complete.

STEP SIX

Peel the protective film from the reflective collar and fit into your flashing tray (if the collar appears loose, bend collar over onto the flashing flange to prevent the collar pulling through).

Fit the outer dome to the flashing using fixings and trim provided and tighten trim.

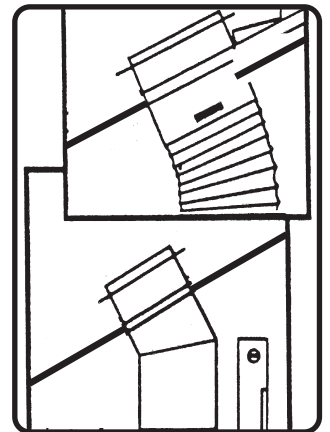

STEP SEVEN

From inside the room concerned, using your centre hole and the architrave provided as your template, mark your cutout (drop sheets are recommended when cutting).

Caution: Before cutting make sure there are no electrical cables or plumbing.

Proceed to cut opening using a handsaw.

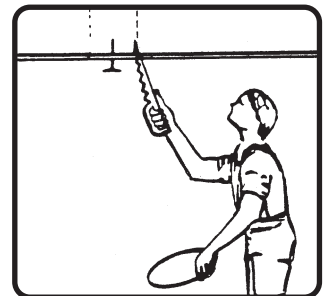

STEP EIGHT

Put the diffuser inside the ceiling before fitting your architrave.

STEP NINE

Now fit the architrave by pushing up into the ceiling opening and screw fix with screws and accessories provided. To fit Flexi Shaft, connect the shaft to the roof collar using the 2 hooks provided. (Hook through Flexi Shaft then hook to slots in collar). Place ceiling diffuser inside Flexi Shaft then connect Flexi Shaft to the ceiling architrave using the 4 U-clips provided. Lower the diffuser down into position on the architrave. If necessary, cut off excess Flexi Shaft as pulling the Shaft tight enhances the Tubelite's performance.

